In this article, we examine least-cost strategies for teaching the greenhouse gas emission reductions specified by the Kyoto protocol for three Canadian provinces, Ontario, Quebec, and Alberta. We analyze four scenarios, each specifying a certain level of cooperation (i.e. of trading of emission permits and of electricity) between the provinces. To effect these analyses, four MARKAL models (one for each province and one for the US) are used in a multi-regional framework that endogenizes energy and permit exchange levels and prices. The US model is included in the analysis in order to correctly simulate the important natural gas market between Canada and the USA. The results indicate that both permit trading and electricity exchanges are capable of significantly reducing the direct costs of abiding by the Kyoto protocol. The paper also includes an analysis of the the main policy issues faced by the three provinces while planning for a concerted effort to abate GHG emissions

Dans cet article, nous étudions des stratégies optimales pour atteindre la cible de réduction des gaz à effet de serre prescrite par le Protocole de Kyoto, dans le cas de trois provinces canadiennes: Ontario, Québec, et Alberta. Nous analysons quatre scénarios, chacun décrivant un niveau différent de coopération entre les trois provinces (c'est à dire d'échanges de permis d'émissions et/ou d'électricité). Pour cette recherche, quatre modèles MARKAL ont été utilisés dans une cadre multi-régional qui endogénise les quantités et les prix des échanges de permis, de gaz naturel, et d'électricité. Le modèle des E.U. a été inclus de façon à bien simuler le marché nord-américain du gaz naturel. Les résultats indiquent que les échanges de permis et les échanges d'électricité sont capables de réduire les coûts de réduction des GES de façon très significative. L'article commente aussi les diverses politiques à considérer lors de la planification d'une implantation concertée des réductions d'émissions de GES.

Dr. Richard Loulou is Professor of Management Science, and Associate Dean Academic, at the Faculty of Management, McGill University. Dr. Amit Kanudia is Adjunct Professor of Management Science and Research Associate at the Faculty of Management, McGill University. Both authors are also members of the GERAD Research Center, "Groupe d'études et de recherche en analyse des décisions".

The Kyoto Protocol, Inter-Provincial Cooperation, and Energy Trading: A Systems Analysis with integrated MARKAL Models

**Richard Loulou,
Amit Kanudia**

1. Introduction

Canada, along with more than one hundred other nations, agreed to the Kyoto Protocol of December 1997 (UNFCCC, 1997). If the treaty is ratified, Canada will have to curb its anthropogenic greenhouse gas emissions (CO₂ equivalent of six gases listed in Annex A of the Protocol) so that its average annual emission over the 5 year period 2008-2012 will not exceed 94% of 1990 emissions. In order to satisfy the protocol, Canadian policy makers will need to answer many questions, such as: How should reductions be allocated to various provinces? Should all reductions be accomplished within Canada alone, or partly by Joint Mitigation with other countries? What are the sectors and subsectors of the Canadian economy that will be asked to effect reductions, and by what amounts? What is the cost of abatement? What are the Policy instruments (e.g. carbon tax, tradeable permits, regulations) that should be chosen to induce the desired abatement in each sector? These questions are difficult, and there is little time to decide what to do, since the present state of Canadian GHG emissions (which today exceed 1990 emissions by 11%) is no cause for optimism.

In this and a companion article (Kanudia and Loulou, 1998a) we attempt answers at several of these questions, with a focus on the efficient allocation of emission reductions to a group of geographical entities (countries or provinces), so as to reach a common reduction target. The present paper analyzes the merit of inter-provincial Joint Mitigation (JM), i.e. the collective attainment of a certain emission target by three Canadian provinces, rather than by each province alone. We thus present the case for a close cooperation by Canadian provinces to achieve significant savings while abiding by the international agreement. The sister article focuses on international Joint Mitigation.

The analysis is based on three advanced, detailed MARKAL bottom-up models of the energy systems of three Canadian provinces (Ontario, Québec, and Alberta). The Québec and Ontario models have been developed at GERAD (Groupe d'études et de recherche en analyse des décisions) and the Alberta model at CERI (Canadian Energy Research Institute) and ARC (Alberta Research Council), and recently harmonized by the authors. The three models may be merged into a multi-region MARKAL, with inter-regional trade variables for any flow of energy or emission permits needed to correctly simulate a particular scenario. Each scenario examines a particular type of cooperation between the provinces, materialized by the trading of GHG emission permits and/or energy between them. By comparing scenarios that allow or disallow these two types of cooperation, one is able to compute the net advantage of cooperation.

We coin the phrase Joint Mitigation (JM) to describe a situation where several players decide to jointly attain the Kyoto (or any other) target, by effecting emission abatement wherever it is most cost-effective, rather than impose specific targets for each player. It is clear that from a conceptual viewpoint, JM is equivalent to an emission permit trading system limited to that group of players. The phrase 'permit trading' will therefore often be used in this article, although it is not our intention to examine the detailed implementation aspects of such a system.

¹ An excellent discussion of permit trading systems is contained in chapter 11 of the Second Assessment Report of the Working Group III of the Intergovernmental Panel on Climate Change (IPCC, 1996).

Although the choice of the three provinces was partly dictated by the availability of detailed MARKAL databases, there is no doubt that they represent three very contrasted geographical regions of Canada, and that they collectively represent very well the country's energy and economic diversity². Together, the three provinces represent 67% of the country's population, 70% of its GDP, and 73% of its GHG emissions. We do expect that most of the insights gained from this research would be extendable to the rest of the Canadian regions, with some additional analysis. In this paper, we shall somewhat abusively use the term 'Canada' for all results concerning the set of the three provinces.

The choice of a very disaggregated equilibrium-seeking model such as MARKAL³ has several important advantages for the exploration of GHG mitigation strategies. First, by its very nature, MARKAL does not rule out any action that reduces emissions in a cost efficient manner. Thus, the approach is often able to *devise* strategies (while many other approaches can only *test* abatement strategies proposed by the user). This is an essential feature of equilibrium models, not available in econometric or other simulation approaches. The second advantage arises from the detailed, technology-level nature of MARKAL, which is shared only by a few other bottom-up models. This allows the strategies to be described in a realistic, credible fashion, since every single model recommendation can be explicitly traced back to tangible technological choices and/or behaviours in each subsector of the economy.

Another feature of our work worth stressing, is that it demonstrates the tight interdependence of emission control and energy trade, both within Canada and with the USA. This is an important topic for a country such as Canada, where energy resources play an important and diverse economic role.

² In terms of energy endowment, Quebec possesses a large hydroelectric economic potential, Alberta is richly endowed in oil, natural gas, and coal, whereas Ontario has few primary energy sources.

³ The MARKAL model is described in section 2.

Finally, we shall make some observations regarding the sharing of GHG mitigation costs, although this is not the main goal of this research, mostly aimed at finding efficient abatement strategies.

In section 2, the methodology is outlined, and the three models are briefly described, as well as the scenarios. In section 3, we present and analyze the results obtained, and we conclude in section 4.

2. Methodology: the MARKAL Modeling system

2.1. General features

MARKAL models have existed since 1982 (Fishbone and Abilock, 1981) and have been modified and considerably augmented since then (Berger et al., 1992, Loulou and Lavigne, 1996, Loulou and Kanudia, 1997). In this research, we have used the most advanced version of the model, developed and maintained at GERAD, in collaboration with the ETSAP consortium (Energy Technology Systems Analysis Program, under the aegis of the International Energy Agency). The authors are active members of ETSAP.

MARKAL is a detailed technological bottom-up model⁴ that computes a dynamic partial equilibrium⁵ on energy technology markets over an 8 period horizon. Each period covers 5 years, so that the horizon consists of 40 years. In our study, the periods are centered at years 1995, 2000, 2005, ..., 2030. The model uses a detailed, explicit technological description of a region's Reference Energy/Environment System (RES), i.e. a set of activities that have energy or environmental inputs and/or outputs. The RES includes the sources, transformation, transport, and end-uses of energy forms, as well as a set of disaggregated economic

demands in all sectors and sub-sectors of the economy. Each technology is described by its technical parameters (mix of inputs and outputs, efficiency, physical lifetime, availability date, etc.), and by a set of economic parameters, such as its acquisition cost, annual fixed cost, variable costs, bounds on market shares, etc. In addition, each technology has a so-called 'residual capacity' at the beginning of the horizon (1993 in our case), indicating the initially existing capacity and its future profile of abandonment. Residual capacities constitute an accurate and detailed description of the RES as it exists at the initial period.

The technologies are inter-related by flows of energy carriers, materials, and other commodities. Among these flows, atmospheric emissions play a particular role, as they are often the subject of scenarios. In fact, environmental considerations have led to a significant increase of the technological database, as many technologies are specifically devoted to emission abatement. *In fine*, GHG emission reduction may be achieved via energy and technology replacements, conservation measures, industrial process switching, and endogenous reduction of economic demands, as explained in the next paragraph. Note that the removal and deep storage of GHG is not modeled in our current databases, and neither are carbon sinks such as afforestation or enhanced forest management.

In MARKAL, economic demands (e.g. number of apartments to heat, kilometers of urban car travel, or tonnes of aluminum to produce) are specified exogenously only for the base scenario. When other scenarios are run, the demands may be altered endogenously by the model, since they are elastic to their own prices⁶. As already noted, this confers greater economic scope to the model, and captures a great deal of the interaction between the energy system and the economy.⁷

⁴ However, contrary to traditional bottom-up models, MARKAL assumes that economic demands are elastic to their own prices. This feature takes MARKAL some distance toward closing the gap between bottom-up and top-down models.

⁵ A dynamic partial equilibrium ensures that the market's demands are satisfied at each period at certain prices computed endogenously. In MARKAL, the prices are equal to the marginal values of the energy and material forms present in the model. However, these marginal prices are not necessarily those of a pure deregulated market, since the model may well include many market imperfections (such as imposed market share limits, taxes/subsidies) that the user chooses to include.

⁶ Since the price of a particular demand is also endogenously determined in the model, a special mathematical device is used to implement the price-demand relationship, see Loulou and Lavigne (1996) for details.

⁷ see Loulou and Lavigne, 1996, for a more substantial discussion of this point. In this project, we have actually deactivated the elastic demand feature, so as to obtain a purely technological response from the various RES's to te

A model run is fully determined by four types of data: the technological database, the demand scenario, the prices of imported energy forms, and the environmental scenario. We will present the five scenarios for this research at the end of this section.

The 'engine' used to compute the partial equilibrium is Linear Programming (L.P.). The objective function minimized is the sum of direct costs

(investment, O&M, variable costs, taxes/subsidies) and of the loss of consumer surplus resulting from any change in the demand levels compared to the base case. The physical, logical, financial, and policy conditions of the RES are represented by constraints in the L.P. (equalities and inequalities). A typical MARKAL model may have from 5,000 to more than 12,000 constraints, depending to the level of detail and the number of periods.

MARKAL has two additional capabilities which give it much flexibility, namely the handling of uncertain events (Kanudia and Loulou, 1998, Loulou and Kanudia, 1997), and the multi-regional feature (Loulou et al., 1996). In this study, we have not modeled uncertainties. On the other hand, the multi-regional feature plays a central role in our scenarios: it allows several MARKAL models representing different regions to be merged into a single model, with a single joint objective function to minimize, and with special exchange variables representing the trading of various commodities between the regions.

2.2. The three provincial MARKAL models: a brief description

The detailed descriptions of the databases have appeared in previous separate publications. Figure 1 is a synthetic view of the Ontario Reference Energy System (RES), indicating the level of disaggregation in each subsector, via the number of technologies used to describe it. The other databases are of quite comparable size and detail, with however somewhat less end-use detail in the case of Alberta and India. All three models are nevertheless much more detailed than the global models used for international mitigation in the extant literature.

It is worth stressing here some technological assumptions built in the databases. In general, it may be said that the models have very comparable sets of technologies, whenever these technologies are not geography-specific (such as hydroelectricity, wind or solar potential, etc.). For instance, natural gas fuel cells, transportation vehicles, or electric baseboard space heaters are modelled identically in all systems. However, there is one important exception to this, concerning nuclear electricity generation, which has been frozen until 2020 in all three provinces, for reasons which are socio-political more than technical. This assumption is especially important for the Ontario and Alberta energy system, as we shall see in the sequel. In a variant scenario, we have briefly investigated the impact of allowing nuclear energy in 2010 in Alberta.

2.3. The Scenarios

Scenarios are built around two sets of assumptions. One set pertains to the future economic outlook and the other to the carbon mitigation level and trading strategies.

Economic scenario

Throughout this research, we have used a single scenario for economic demands and world energy prices. The underlying assumption is that the Canadian GDP grows at a moderate rate until 2020, and then slows down. The rates vary across the three provinces, with Quebec having the lowest growth rate, but remain within the 2 to 2.4% bracket until 2020, and within the 1.7-2.0

environmental constraints.

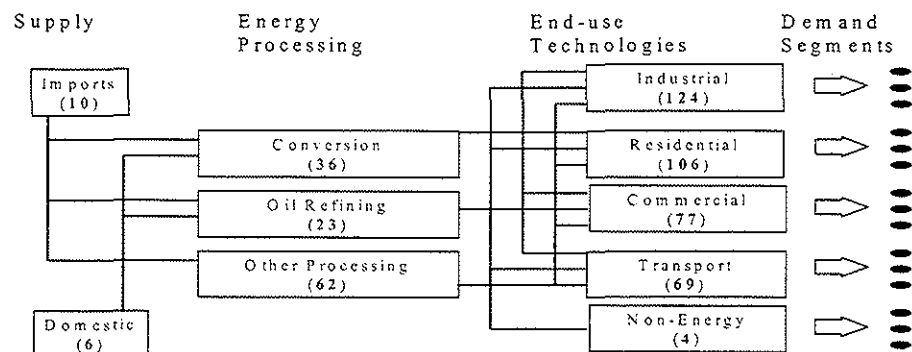

Figure 1. A typical MARKAL Reference Energy System (Ontario)

bracket after that date. Of course, each demand segment has its own specific growth pattern in the scenario. Residential and heavy industrial demands grow rather more slowly than road and air transportation, commercial, and light industry demand segments. The prices of crude oil and gas converge in 2005, and on average grow at 1% /yr. until 2010, and then stagnate at their 2010 levels, which are equivalent to US\$20 per barrel. These assumptions follow the Canadian Government central forecasts contained in the *Energy Outlook to 2020 (Natural Resources Canada, April 1997)*.

Five Emission and Trade Scenarios

Five contrasted scenarios are studied, each representing a particular combination of conditions on three elements: the GHG emission reduction target (i.e. unrestricted or Kyoto+ target), the amount of new electricity trade allowed between the regions (i.e. between Québec and Ontario), and the level of co-operation on GHG mitigation allowed between the three provinces. The five scenarios are described in Table 1, but before, we describe what is the Kyoto+ target.

The Kyoto+ target: consists of the Kyoto Protocol target for 2010 (i.e. 96% of the 1990 emission level in Canada), extrapolated to 80% of 1990 emissions in 2035. Emission levels at intermediate periods between 2010 and 2035 are interpolated linearly.

Comments

- In all scenarios, gas trade remains endogenous in our models, not only between Canadian provinces, but also between USA and Canada. This means that the four MARKAL models (the 3 Canadian provinces and the US model) are run as a single multi-region model with endogenous gas trade variables defined for each time period.
- The *Base Case* scenario does not impose any GHG emission constraint. However, since each energy system is optimized over the horizon, some 'no regret' GHG abatement does take place, relative to an unknown 'business-as-usual' case.
- *Kyoto-G* assumes joint mitigation by the three provinces, i.e. there are now endogenous emission permit trading variables for each province, at each time period.

Table 1: The Five Scenarios

Scenario	Description
Base Case	No GHG emission constraints. Gas trading allowed within North America.
Kyoto-NC	Each province reaches its Kyoto+ target individually (no permit trading). Electricity trade limited to current level. Gas trading allowed in North America
Kyoto-G	Joint Mitigation by the three provinces to reach Joint Kyoto+ target. Electricity trade limited to current level. Gas trading allowed in North America.
Kyoto-E	Each province reaches its Kyoto+ target individually (no permit trading). Electricity trading allowed between Québec-Ontario. Gas trading allowed in North America.
Kyoto-G+E	Joint Mitigation by the three provinces to reach Joint Kyoto+ target. Electricity trade allowed between Québec-Ontario. Gas trading allowed in North America.

Note: The GHG reduction in the period 2008-2012 mentioned in the Kyoto Protocol, has been modeled as follows: the MARKAL model emissions account only for the energy sector's emissions, which represent 77% of total anthropogenic GHG emissions in Canada. Therefore, the Canadian reduction target has been set at $6\% \times (1/0.77) = 7.8\%$ of the energy sector's 1990 emissions. After 2012, it has been assumed that the reduction effort would not cease, but rather than additional reductions would be imposed reaching 20% of 1990 levels in 2035.

- *Kyoto-E* assumes no permit trading, but allows electricity trade expansion between Québec and Ontario, by means of endogenous capacity and flow variables between the two provinces.
- *Kyoto-G+E* allows both permit trading and expanded electricity trade, by means of appropriate endogenous variables.
- *Permit and Energy Pricing*: the prices at which permits and energy are sold are not directly relevant for the determination of the globally optimal strategy, since when several models are jointly optimized, the revenue and payments cancel out. However, a price is quite essential in computing the allocation of the benefits of trade. In the results presented in section 3, traded permits and energy are priced at their marginal value⁸. Such a pricing scheme is compatible with conventional perfectly competitive market economics⁹.

⁸ The marginal system value (or shadow price) of a commodity is readily obtained as the optimal dual value of the balance constraint of that commodity in the MARKAL equilibrium solution

⁹ To be exact, shadow prices can also reflect some market imperfections, if these have been included in the MARKAL models. Examples are: taxes, subsidies, regulatory constraints, etc., which, if incorporated in a MARKAL data base, will affect

although it could be unrealistic when market imperfections are present (for example if the market for permits is oligopolistic).

- *Energy trading*: as already mentioned, in all scenarios, it is assumed that natural gas trading within Canada and between Canada and the US is allowed, and endogenously determined by the model. The reason for this is that the North American gas market is mature and fully integrated. Such is not the case of *electricity trading*, which requires for its future development significant policy decisions, as well as investments in new transmission lines. In the Base Case, the Kyoto-NC, and the Kyoto-G scenarios, no electricity trade expansion is allowed beyond the currently existing line capacity (which is moderately small). In the other two scenarios, unlimited investment in new transmission capacity between Québec and Ontario is endogenous to the model. Just like emission permits, electricity and gas are priced at their respective marginal values when computing the net trade revenues of the trade partners.

the values of the shadow prices.

3. Results and Analysis

(all costs are in C⁹⁵\$, and discounting is effected to year 1995)

3.1. Net total discounted costs

The Kyoto+ target is reached at total discounted direct costs shown in Table 1 (for each province, and total). The second part of the table shows the savings accrued in the cooperation scenarios, relative to NC. Recall that the direct costs incurred by each province include the acquisition and operation costs of all technologies, the costs of extracting and importing primary energy forms, including the payments effected for permits and/or energy traded (priced at their marginal cost, as discussed in section 2). These costs are decreased by

all revenues accrued from selling energy forms and permits, also priced at marginal value.

In Table 1, we show within brackets the percentages of provincial GDP these costs represent. The costs are significant, except for Québec. Also significant are the savings accrued from various levels of cooperation, except for Alberta, where cooperation has little impact on the cost of abatement. Overall, with the full cooperation scenario (Kyoto-G+E), costs are reduced by about one fourth, to reach 0.45% of GDP, as opposed to 0.6% in the NC scenario. In absolute terms, the trading of emissions among the three regions, and of electricity between Québec and Ontario, results in overall substantial savings of \$21 Billion.

Table 1. Total discounted system cost over the model's horizon[#]

	Québec	Ontario	Alberta	Canada
<i>Incremental Costs Over Base (C⁹⁵\$Billion, and percent of GDP)</i>				
Kyoto-NC	3.6 (0.1%)	63.5 (0.8%)	20.7 (0.8%)	87.8 (0.6%)
Kyoto-G	0.24 (0.01%)	56.0 (0.6%)	20.4 (0.8%)	76.7 (0.52%)
Kyoto-E	-0.8 (-0.03%)	49.4 (0.5%)	20.6 (0.8%)	69.1 (0.47%)
Kyoto-G+E	-1.8 (-0.06%)	48.7 (0.5%)	20.0 (0.8%)	66.9 (0.45%)
<i>Savings Over No Cooperation Scenario (C⁹⁵\$Billion)</i>				
Kyoto-G	3.4	7.5	0.3	11.1
Kyoto-E	4.4	14.1	0.1	18.7
Kyoto-G+E	5.4	14.8	0.7	20.9

[#] Divide by 22 to obtain an equivalent annual cost

Cost Breakdown

It is instructive to examine the components of the costs shown in table 1, especially as concerns the revenues and payments for energy and GHG permits traded by the provinces. This is done in table 2, and briefly commented now.

Table 2. Cost breakdown (B\$): all figures are relative to the Base Case

	Technology Cost	Payments for GHG	Payments for ELC	Payments for NatGas	for TOTAL COST
Quebec					
Base Case	0.0	0,0	0,0	0,0	0,0
Kyoto: NC	5.0	0,0	0,0	-1,3	3,6
C--KG-	14.0	-11,1	0,0	-2,6	0,2
C--K-E	34.0	0,0	-36,7	2,1	-0,8
C--KGE	35.0	-0,2	-38,7	2,1	-1,8
Ontario					
Base Case	0.0	0,0	0,0	0,0	0,0
Kyoto: NC	70.0	0,0	0,0	- 6,8	63,5
C--KG-	43.0	15,0	0,0	- 2,1	56,0
C--K-E	25.0	0,0	36,7	-12,0	49,4
C--KGE	16.0	3,4	38,7	- 9,4	48,7
Alberta					
Base Case	0.0	0,0	0,0	0,0	0,0
Kyoto: NC	17.0	0,0	0,0	4,0	20,7
C--KG-	23.0	-4,0	0,0	1,2	20,4
C--K-E	17.0	0,0	0,0	4,1	20,6
C--KGE	22.0	-3,2	0,0	1,3	20,0

For Quebec, it is quite clear that electricity sales, when allowed, are of crucial importance to reduce its abatement cost to zero (or even make it negative). However, these revenues are for a large part offset by increased payments for natural gas. GHG revenue is large only in the G scenario, and almost nil in the G-E scenario, since in that case electricity is a better commodity to trade than GHG permits.

For Ontario, the situation for gas payments is reversed: its gas payments drop considerably when electricity trade with Quebec is opened. GHG permit payments are also greatly decreased when electricity is traded.

For Alberta, the cost of decreased gas sales (to Ontario and Quebec) occurs mostly in NC and E scenarios. The reason differs in these two cases: in NC, gas is less desirable in Ontario and Quebec, because it is not the best way to severely abate emissions. In the E scenario, Quebec's electricity partially displaces gas in Ontario. Conversely, when GHG permits are exchanged, gas becomes attractive in Ontario,

since local abatement is lessened. Note that these decreases in gas revenues are almost perfectly compensated by gas sales to other clients (notably the USA), as witnessed by the almost constant total cost in Alberta.

The Equity issue: a brief comment

A glimpse at the equity issue may be gained by examining the costs per capita incurred by each province, as shown in table 3. Alberta has the highest abatement cost per capita, followed by Ontario, and lastly by Québec, whose costs per capita are quite small, or even negative, due to electricity revenues. It is therefore apparent that the pricing of permits at marginal cost does not by itself remedy the inequalities in GHG cost abatement across provinces. This is so because the permit allocation (endowment) assumed in our

Table 3: Discounted direct mitigation costs per capita[#]

	Québec	Ontario	Alberta	Average
<i>Incremental cost over Base (C⁹⁵\$/capita)</i>				
Kyoto-NC	520	6480	6900	4460
Kyoto-G	35	5710	6800	3890
Kyoto-E	-120	5040	6870	3510
Kyoto-G+E	-260	4970	6670	3400

[#] Divide by 22 to obtain an equivalent annual payment over 40 years.

scheme (proportional to 1990 emission levels) is fundamentally inequitable when equity is taken to mean equal cost per capita. Other, more equitable permit allocations would have to account for the populations of the provinces, and for their particular energy situations¹⁰. It is worth repeating here that the permit allocation has no bearing on the *efficient* abatement strategies found by our model, whenever permit trading is allowed. To illustrate the magnitude of the costs: in the full cooperation scenario, every Ontarian incurs a net abatement cost of \$4970, equivalent to annual payments of \$225 per year for forty years (when discounted at 5%). To give an idea of the relative magnitude of such a cost, the average Ontario revenue per capita was about \$29,000 per year in 1996, and the per capita expenditures for garden supplies by an average Canadian was \$150 in 1997. In Alberta, the annual cost per capita is \$303 (i.e. 6670/22) in the full cooperation scenario, a rather larger sum than Ontario.

3.2. Marginal mitigation costs (table 4)

¹⁰ Contrary to other economic endowments (e.g. energy resources), emission permit endowment does not derive from natural conditions, but from a conventional societal agreement. Therefore, the allocation of permits is really a socio-political issue which may only be resolved via negotiations. Two extreme views of equity can be opposed: the first view recommends *equal abatement cost per capita*, and is obviously largely violated (in favor of Quebec) in our scenarios. Another recommends *equal emission permits per capita*, and, although not evaluated here, would attribute much less permits to Alberta than our present scheme, and more to Ontario and Quebec. Therefore, this second equity principle, if implemented, would worsen Alberta's position as concerns the abatement cost per capita. Note that even equalizing costs-per-capita may not represent a perfectly equitable solution because it ignores differences in provincial wealth.

Interpreting marginal costs is always a complex exercise, but provides a privileged view of the techno-economics of the system being studied.

Looking at the regions individually, Quebec has the lowest marginal costs of GHG abatement in the NC scenario, signaling that Quebec's hydro electricity is able to replace other fuels (mainly gas and heating oil) in a relatively economical fashion. In Alberta, marginal costs are high in 2010 and after 2020. In 2010, this is due to the difficulty of abiding by Kyoto while simultaneously continuing to extract (and sell) its natural resources, as will be discussed in later subsections. In later periods, the high marginal cost reflects Alberta's difficulty in reconciling its abatement with a rather high economic growth.

Both Alberta and Ontario do have some low cost options to replace their coal generated electricity, but these options are insufficient to reach the Kyoto+ target, and more expensive substitutions are selected in end-use sectors, reflected in the high marginal costs. Note that the two provinces have high marginal cost even though nuclear electricity becomes available in 2020, albeit at a rather high production cost.

Québec has some but not many substitution options on the supply side, since its primary energy composition already has very low carbon intensity (due to the hydro dominated electricity production). Initially, abatement is very cheap because electricity from available capacity surplus replaces oil and gas for residential and commercial heating (and somewhat in transport).

Table 4: Marginal Costs of GHG Abatement (\$/Tonne of CO₂-Equivalent)

	2010	2015	2020	2025	2030
No Cooperation					
Quebec	21	5	46	117	168
Ontario	100	413	151	171	475
Alberta	163	138	88	137	195
Electricity Exchange					
Quebec	73	83	129	144	442
Ontario	74	99	132	152	449
Alberta	165	138	87	139	197
GHG permit Exchange					
Canada	106	136	99	130	317
Full Cooperation					
Canada	95	110	94	141	352

The cost increases moderately later on, when this substitution forces fresh investment in small hydro capacity. The hydroelectric resource also allows Quebec to abate its emissions beyond the Kyoto+ target, and therefore to sell emission permits to the other two provinces in the G scenario. Of course, when permit trading is allowed, all provincial shadow prices equalize in table 4, but at a level which is rather high, showing that the abatement target is indeed challenging for Canada.

3.3. Permit and Energy Trading

Permit trading

Without electricity trading, Ontario buys an average of 13.6 million tonnes of GHG permits annually, 4.1 from Alberta and 9.5 from Québec (Figure 2). Allowing electricity markedly modifies the GHG permit trading (Figure 3): Ontario now buys only 3.4 million tonnes of GHG on average per year, mostly from Alberta. Québec neither buys nor sells significant amounts of

GHG permits (this is so because Québec's electricity is a better option for Ontario than buying GHG permits from Québec). Note that Alberta is a net seller of permits on average, but that it buys permits in 2010, in both scenarios. This reflects the difficulty for that province to abide by the 2010 emission constraint and at the same time to continue to extract and sell its natural resources, an activity which emits much CO₂.

In the case when both GHG and electricity are traded, the situation is quite interesting: Quebec and Ontario *both sell* permits to Alberta in 2010, but *both buy* permits from Alberta after 2015. This is so because Quebec, having sold much hydro electricity to Ontario, now has limited abatement options, and prefers to buy some permits from Alberta.

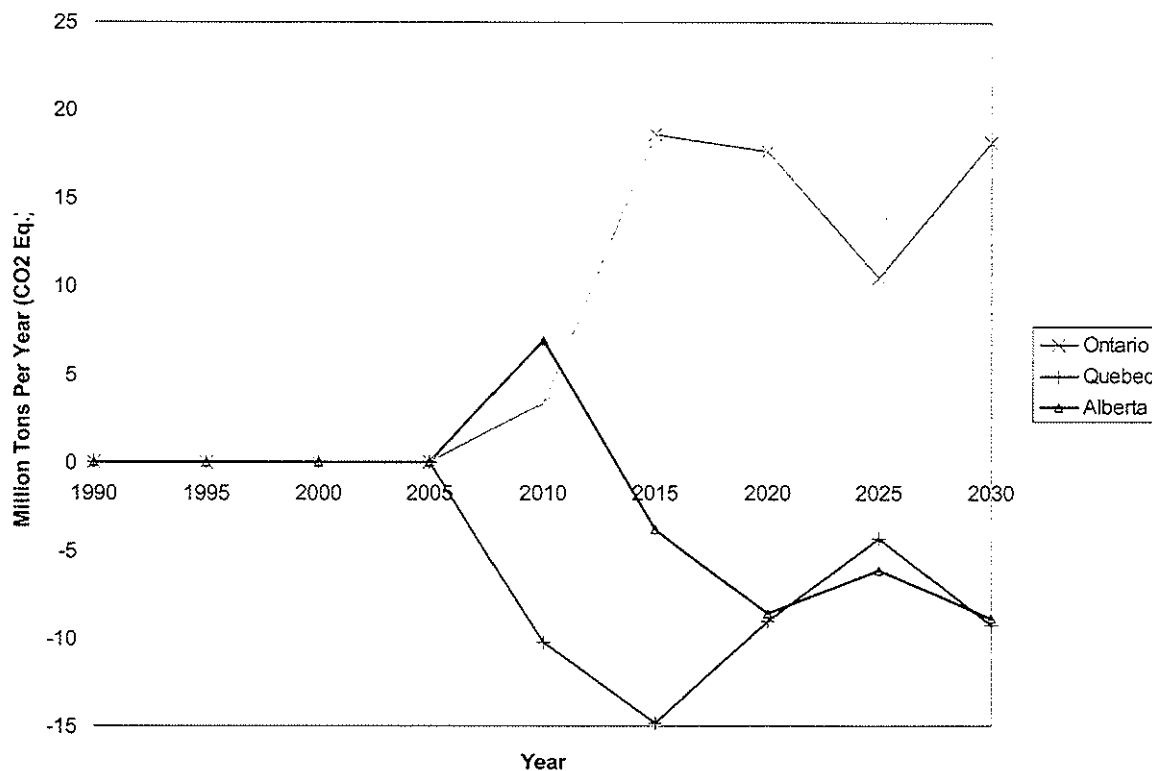

Figure 2. GHG Permit Exchange without Electricity Trading

Electricity trading

Whenever electricity trading is allowed, it takes place at a significant level, irrespective of whether or not permit trading is allowed (figure 4). On average, Québec sells around 200 PJ of electricity each year to Ontario, with a peak of 230 PJ in 2030. This means an additional installed hydro capacity of 12 Gigawatts in 2030, an amount well within Québec's hydro potential. Note that we have not constrained the trade capacity between the two provinces, and hence the amount of trade is governed solely by the techno-economics of the supplying and buying partners¹¹.

Natural gas trading

Natural Gas is an important commodity in the Albertan economy. Throughout the scenarios analyzed, gas exports to Ontario and Québec fluctuate (figure 5 shows exports to Ontario, the largest client), reaching their lowest levels in the Kyoto-E and E+G cases. This is so mostly because Québec's electricity partially replaces natural gas in Ontario, as a more thorough means of abating GHG emissions there. In spite of these fluctuations, an important finding is that cumulative gas extraction in Alberta remains remarkably constant across all scenarios, with less sales within Canada being compensated by more sales to the USA. This point is discussed in more detail in the subsection on the Alberta energy results (see also Figure 15)

¹¹ In the companion article on international joint mitigation, electricity sale to the USA compete with those to Ontario, raising the hydro investments in Québec to higher levels.

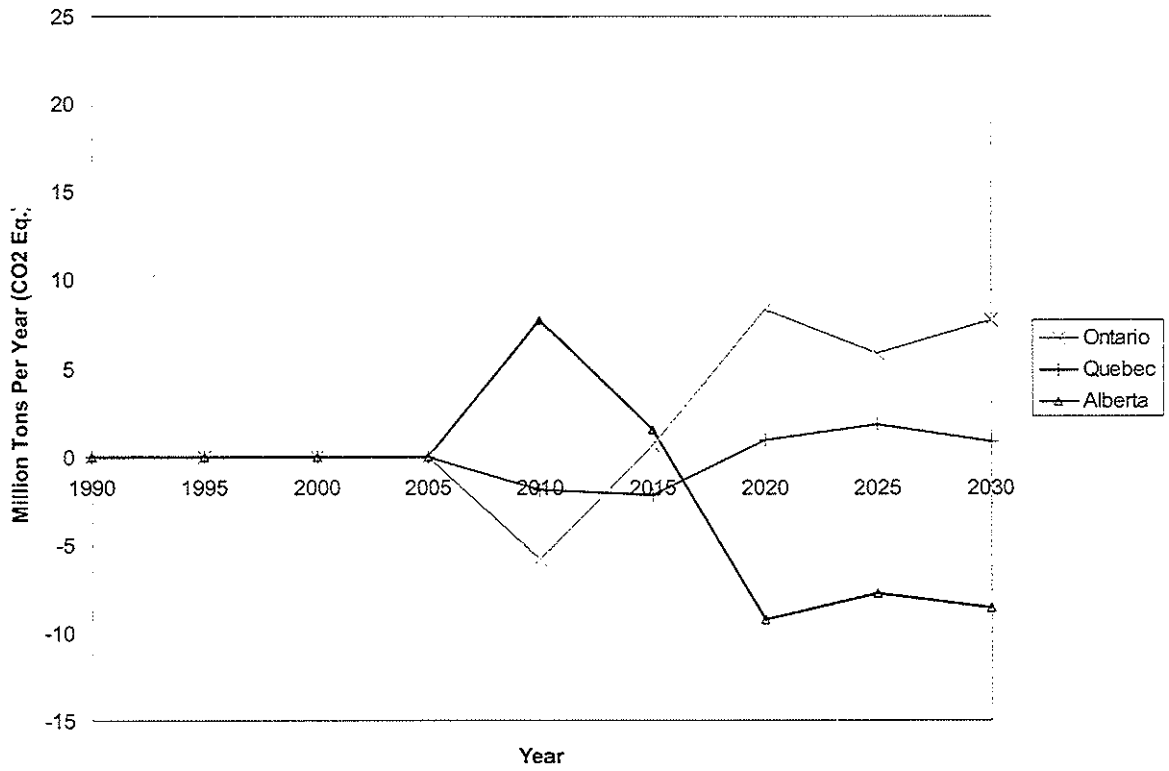

Figure 3. GHG Permit Exchange under the full Cooperation Scenario

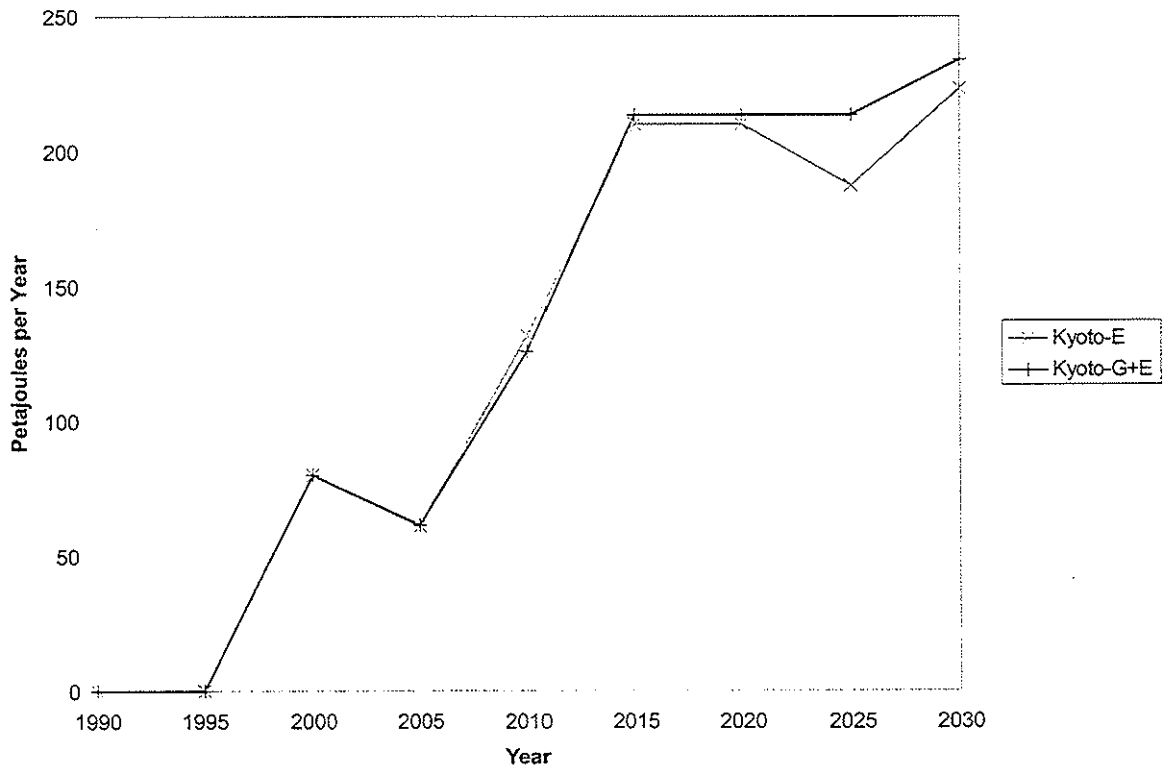

Figure 4 Electricity Export from Québec to Ontario

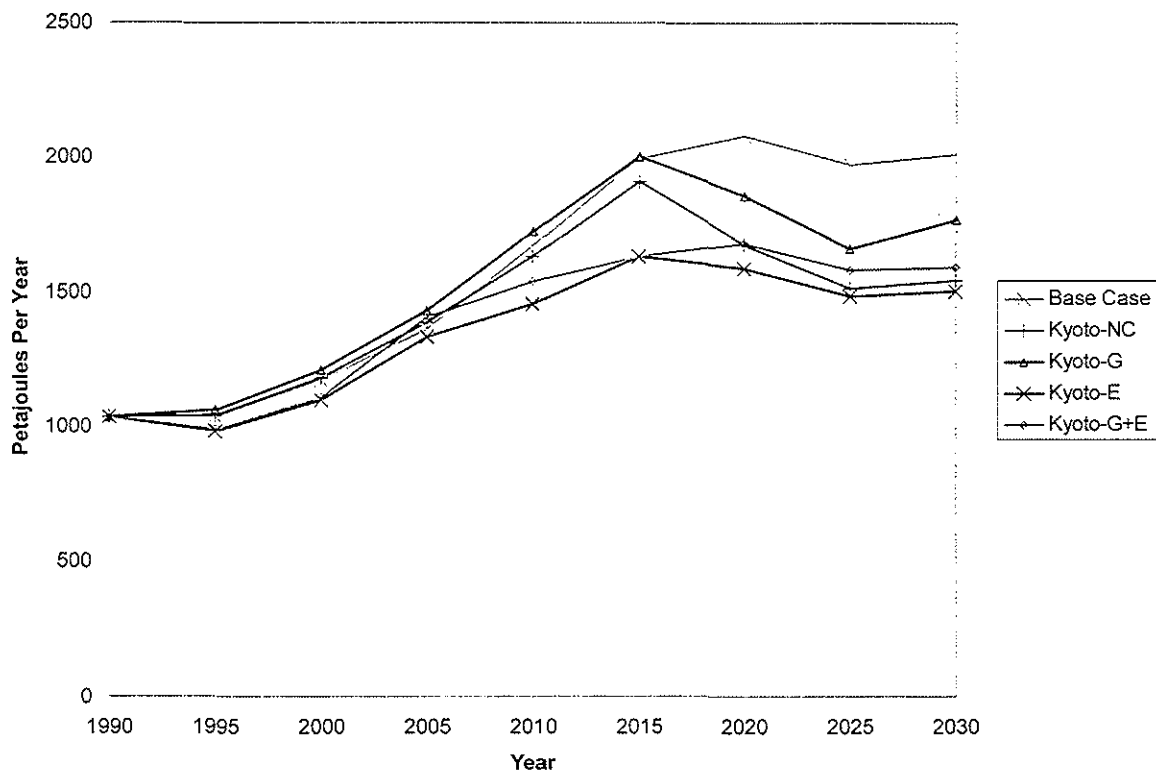

Figure 5 Gas Export from Alberta to Ontario

3.4. Energy technology impacts on the three provinces

Figures 6 to 17 show the main energy technology results in selected subsectors of each province. In some cases, we show the full trajectories, and in others (mainly primary energy or electricity generation composition), we exhibit the averages computed over the 2010-2030 period, for each scenario, as well as the 1990 snapshot for comparison purposes. We briefly comment the most significant switches in what follows.

Québec (figures 6 to 9)

Among the three provinces, Québec meets the Kyoto protocol the most easily because with its moderate growth and sufficient hydro resources, the province emits only 6% above the 1990 level, on an average, in the base case

(figure 6). Hence it has a smaller abatement effort to perform. This abatement is done via conservation measures (beyond those effected in the Base Case as *no regret* measures), further use of hydro electricity in all end-use sectors (fig. 8 and 9), extending also to transportation (where hybrid electric-gasoline cars conquer part of the market even in the base case). Furthermore, land availability allows fuel crops to produce ethanol and methanol (from switchgrass and wood), which displace even more gasoline and diesel fuels (fig. 7, 9).

In order to export electricity to Ontario, Québec builds significant additional capacity over the base case: 4 GW of large hydro, 3.5 GW of small hydro and 5 GW of wind, by 2010-2015.

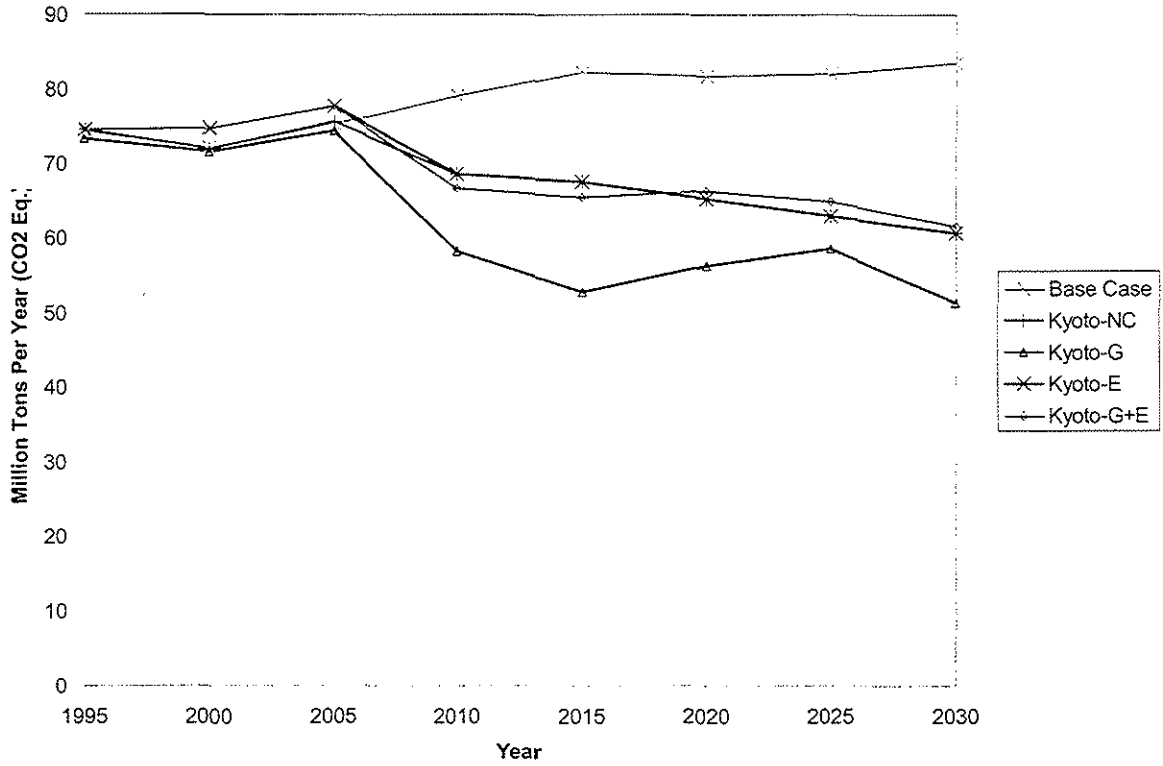

Figure 6 Annual GHG Emission for Quebec

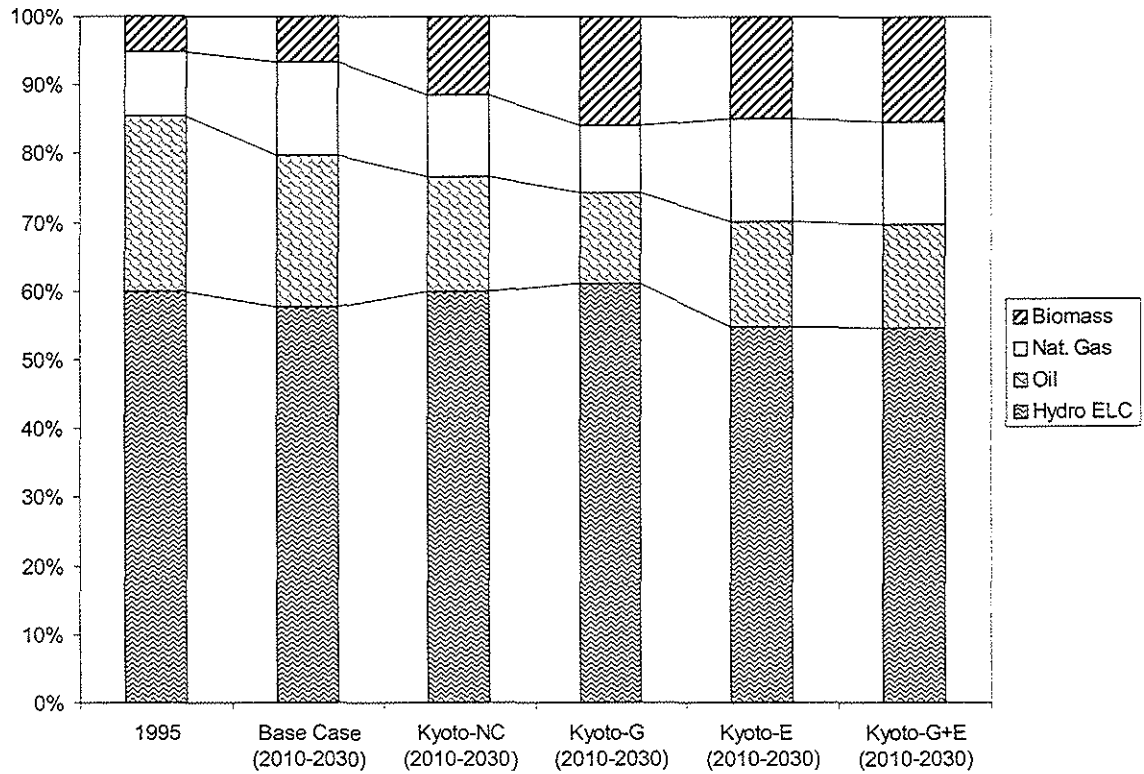

Figure 7 Composition of Primary Energy Consumption for Quebec

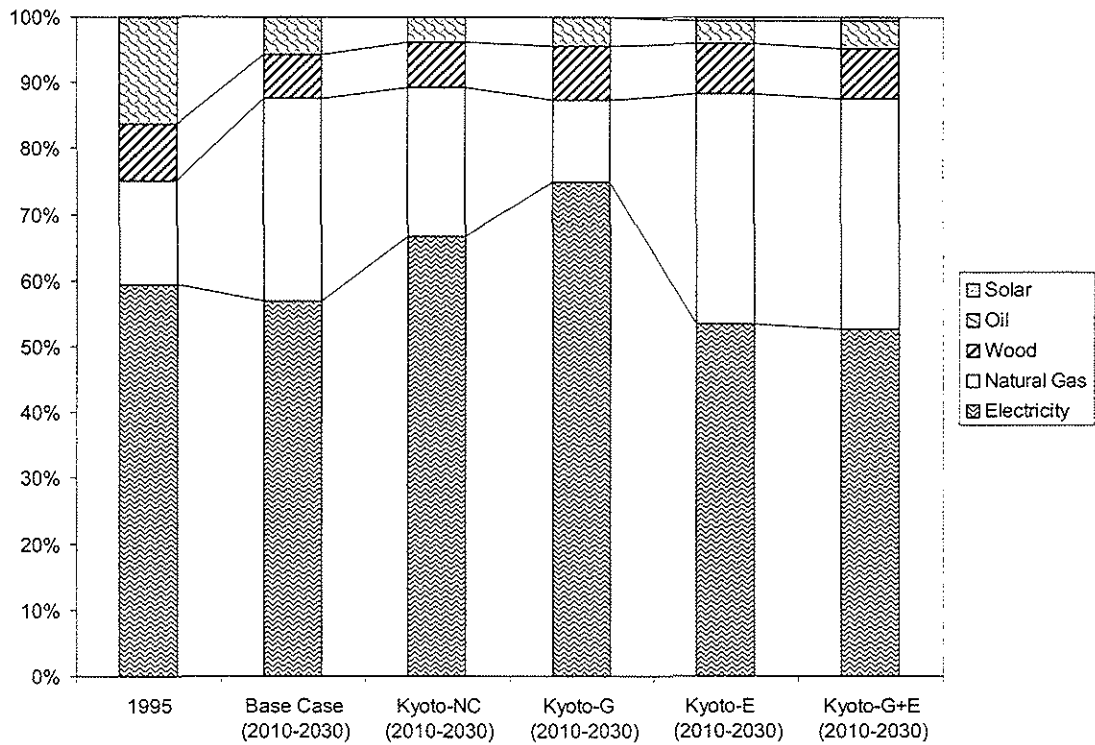

Figure 8 Residential and Commercial Sector Energy Composition for Quebec

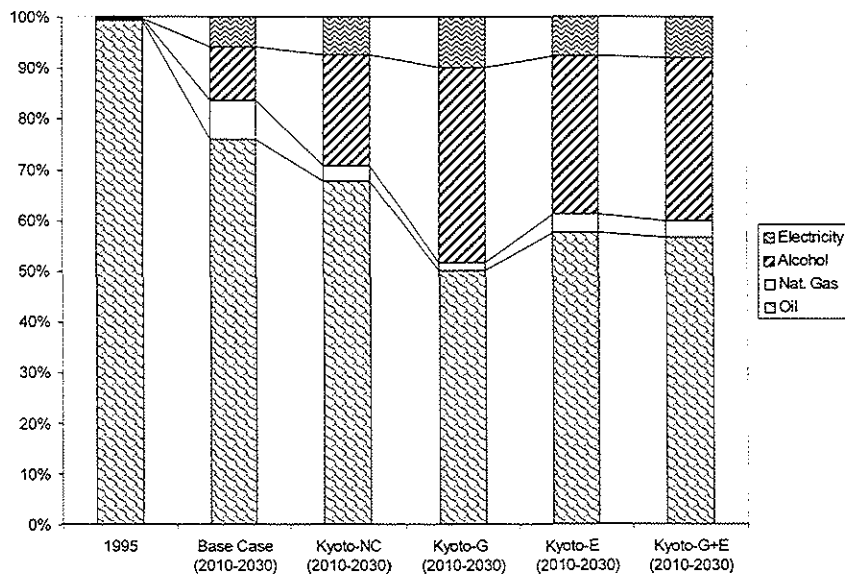

Figure 9 Transport Sector Energy Composition for Quebec

Ontario (figures 10 to 13)

Ontario is the obverse case of Québec: its economic growth rate is higher than Québec's, its new hydro potential is small, and its nuclear is assumed frozen until 2020¹². These reasons make that Ontario's average annual emissions in the base case are 43% above the 1990 level. Hence its abatement effort is considerable, and so is its cost. To alleviate this, Ontario buys enough permits in the two G-trade scenarios to maintain its emissions close to 1990 level. Therefore, Ontario still effects the vast majority of its emission reduction in its own system, and purchases a relatively small amount of permits.

In the Kyoto-NC scenario (the most severe), the major new energy technologies in the electricity generation sector are the gas fuel cell (+6 GW) and nuclear (+8 GW in late periods), which replace coal plants. Conventional gas plants are not selected in the NC scenario, but appear in the three cooperation scenarios, since less local GHG abatement is required then. In the two permit exchange scenarios, fuel cell and nuclear lose ground. When electricity imports from Québec are on (E and G+E scenarios), nuclear capacity is further reduced (14 GW), as well as fuel cells and gas plants. Interestingly, the electricity exchange with Quebec is more effective than permit trading to reduce nuclear in Ontario.

All these energy technology switches are reflected and complemented in the end-use sectors: in the residential sector, NC induces some dual energy space heating systems such as Wood+Electricity, as well as more electric baseboard heating. These technologies are less present when JM is allowed. In the transportation sector, alcohols and a small amount of electricity partly replace petroleum fuels, but less than in the Québec case. Again, these substitutions are partially reversed under cooperation scenarios

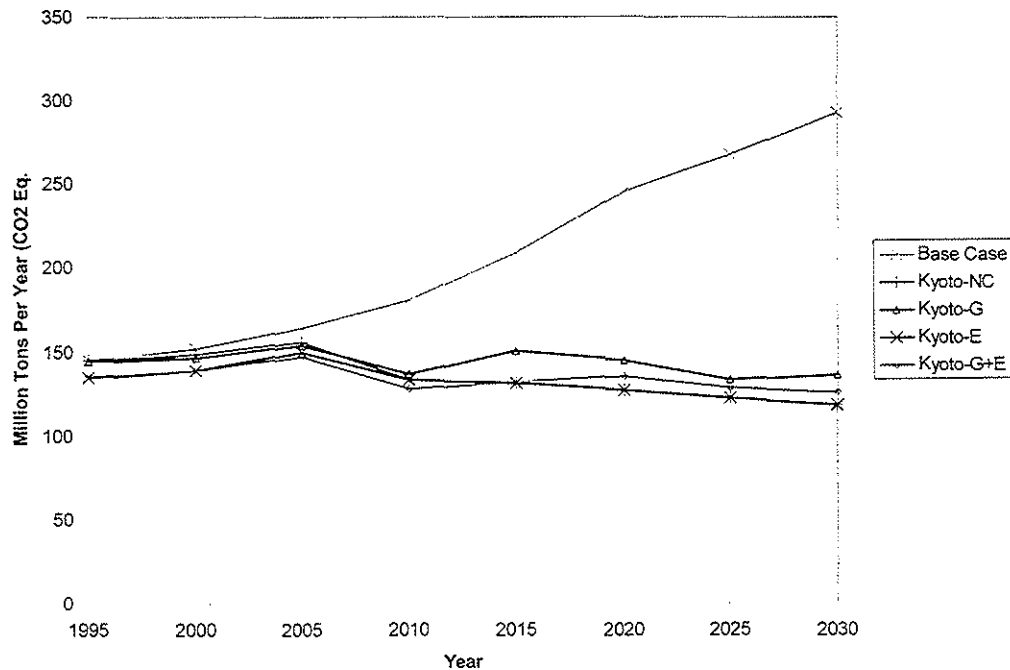

Figure 10 Annual GHG Emission for Ontario

¹² However, even when nuclear is allowed earlier, it does not appear in the base case, although it does in Kyoto cases.

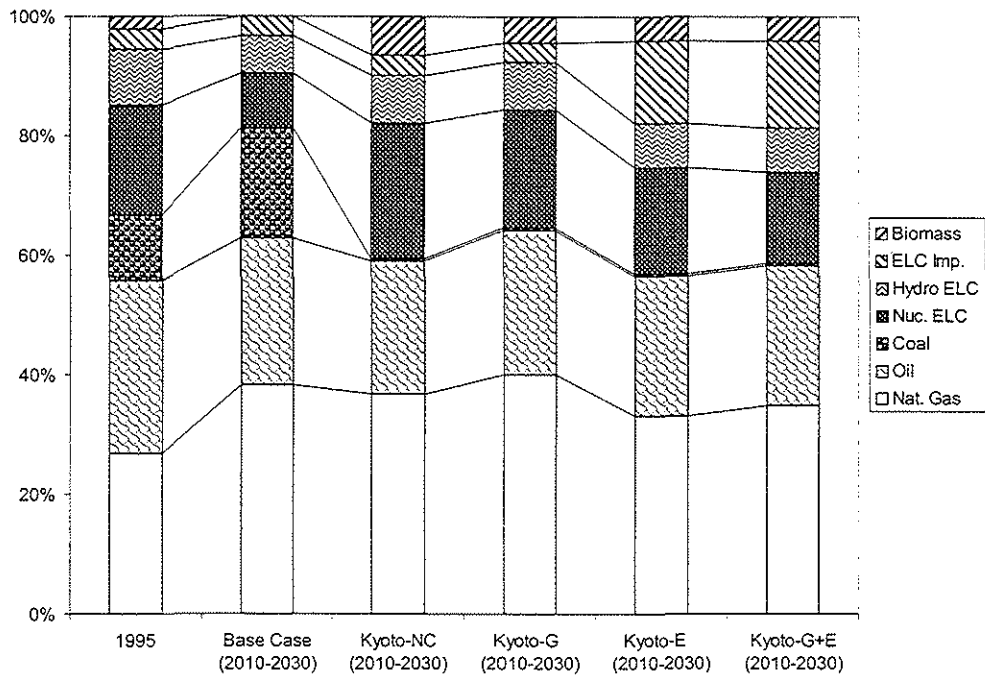

Figure 11 Composition of Primary Energy Consumption for Ontario

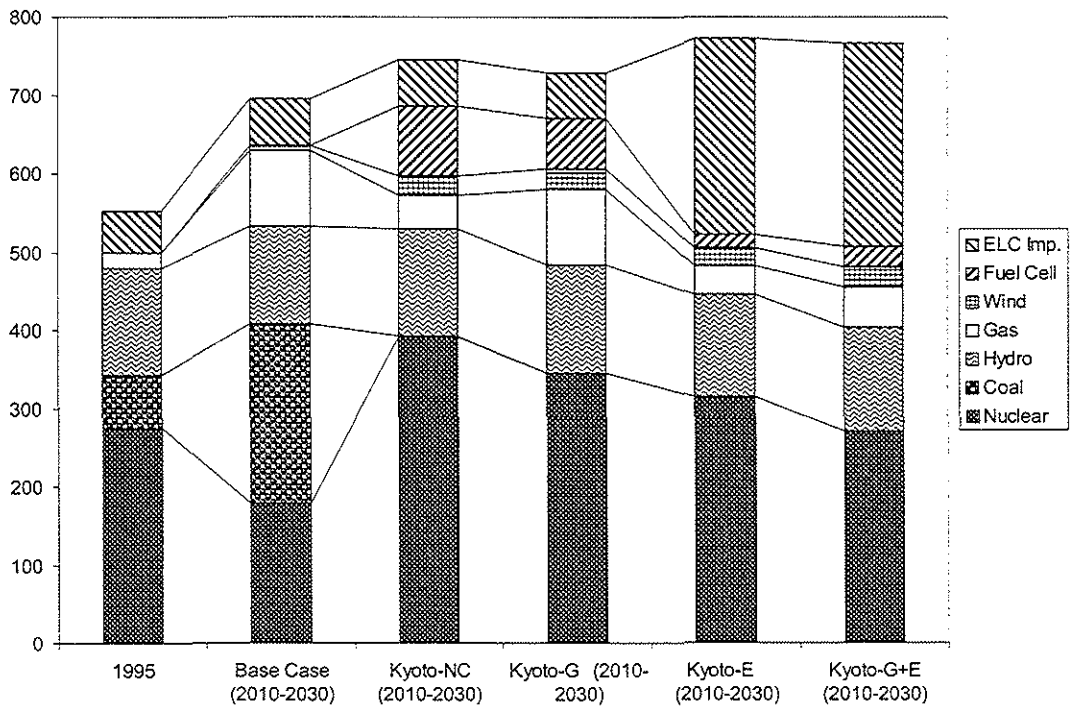

Figure 12 Aggregate Electricity Supply for Ontario

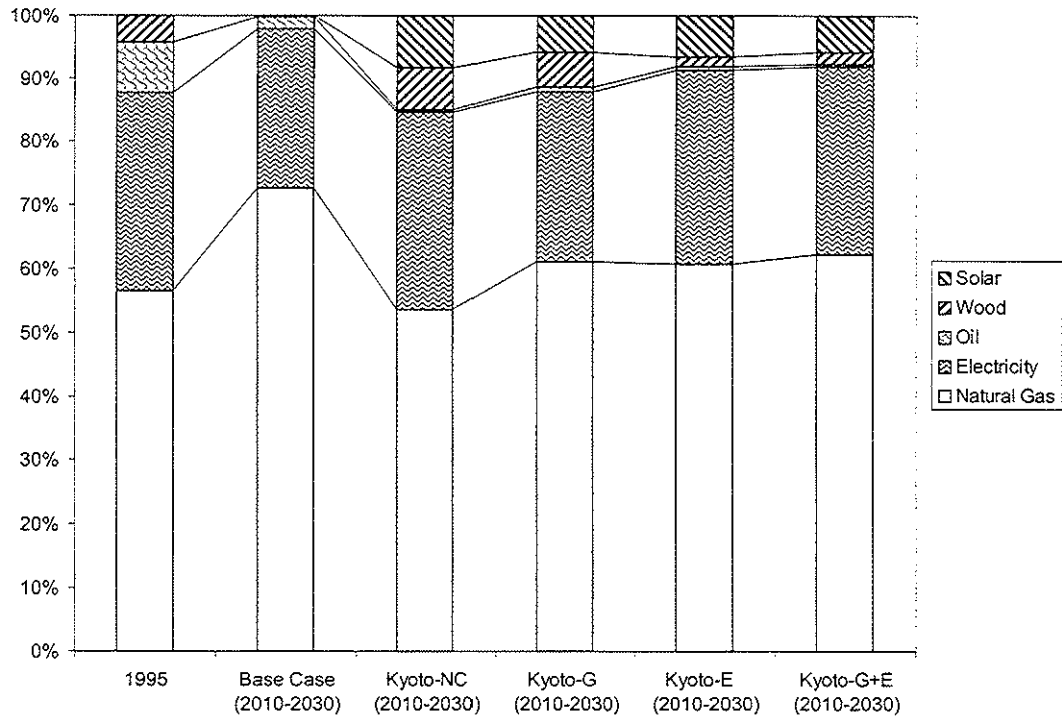

Figure 13 Residential Sector Energy Composition for Ontario

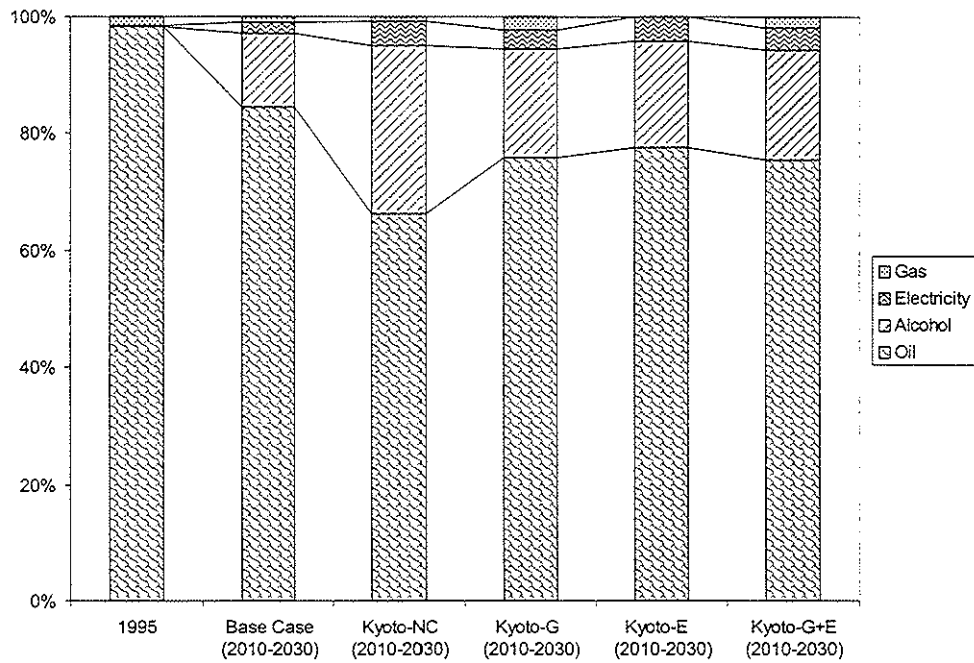

Figure 14 Transport Sector Energy Composition for Ontario

Alberta (figures 15 to 18)

In the base case, average annual GHG emissions in Alberta are 22% above the 1990 level. They tend to stabilize after a quick growth till year 2005, which is driven by fossil energy exports, as shown in figure 15. The initial rise persists across all scenarios, and even with Kyoto, the average emissions over the next thirty years are very close to the 1990 level. Alberta seems to respect Kyoto just by substituting coal with gas and renewable sources in electricity generation (and by small shifts of gas extraction from later periods to earlier periods, as discussed below). In later periods, nuclear plays a significant role. Without cooperation, coal contributes less than 10% in the post 2010 period, which is a big reduction from its 90% share in the base case. Given the option to export permits, it reduces the average emissions by another 3%, mainly by wiping out the remaining coal based electricity generation with small increases in hydro, wind, nuclear and gas based power.

For Alberta, the good news is that energy exports, which account for about 70% of the extraction and a significant part of Alberta's economic activity, remain unaffected in all scenarios (this is not surprising, as an equilibrium model based on cost

minimization will make every attempt to avoid the large opportunity cost resulting from lost sales, even if this means to sell at slightly lower prices a commodity which is less in demand). The average annual exports of natural gas in the post-2010 period are 3-4% higher in the no cooperation Kyoto case as compared to the base case. This is so because Ontario demand for gas is highest when no relief is coming from permit or electricity purchases by that province. Conversely, permit sharing scenarios bring Alberta energy exports close to the base case trajectory after 2010. These post-2010 variations are appropriately compensated before year 2010, and the total extraction over the entire horizon remains constant in all scenarios (figure 15). It turns out that the gas reserves, rather than the emission restrictions, govern total gas exports, although emission restrictions do influence the precise profile of extraction (figure 15). Figure 16 shows in more detail (Base Case only) the extraction of natural gas from different locations, which are grouped in increasing order of cost. NGL represents natural gas liquids, the only source with a small remaining reserve after year 2030. The undiscovered, more expensive sources of gas are not chosen by the model in any scenario.

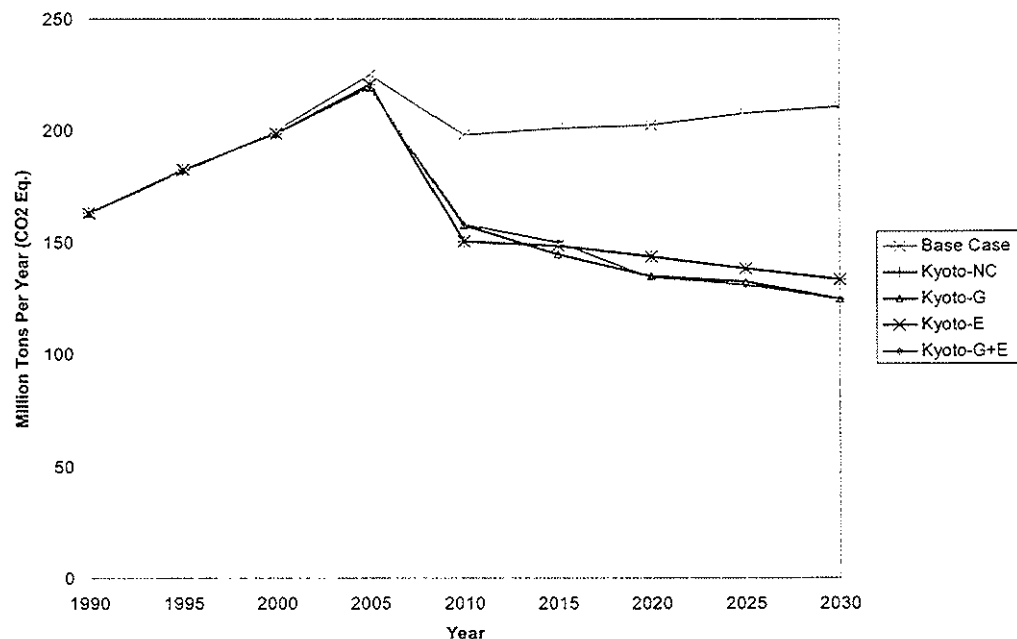

Figure 15 Annual GHG Emission for Alberta

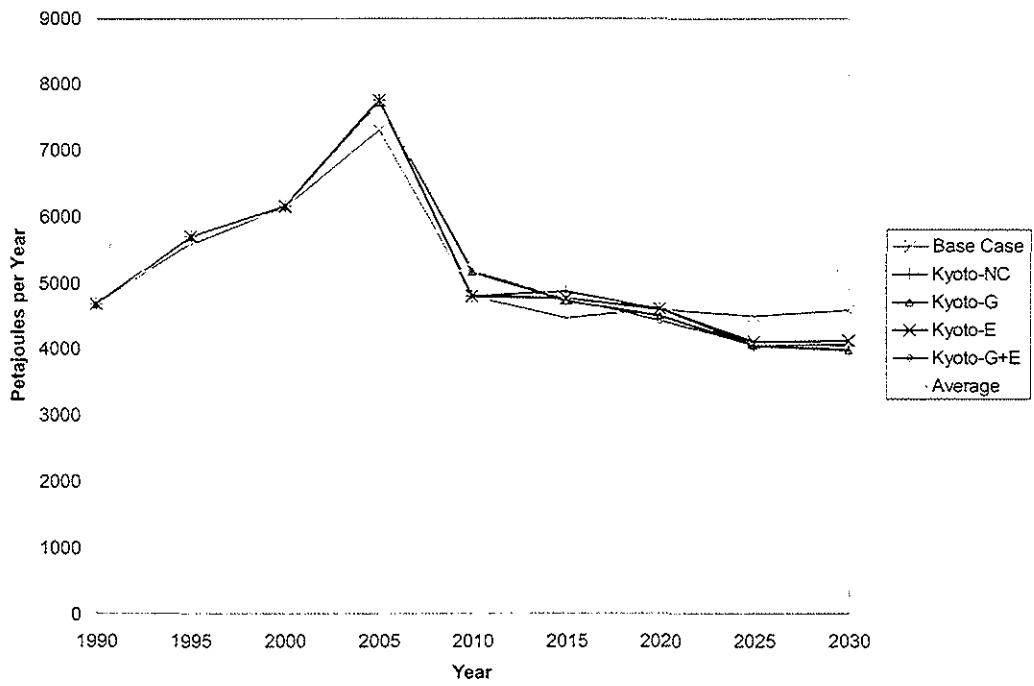

Figure 16 Total Gas Extraction in Alberta

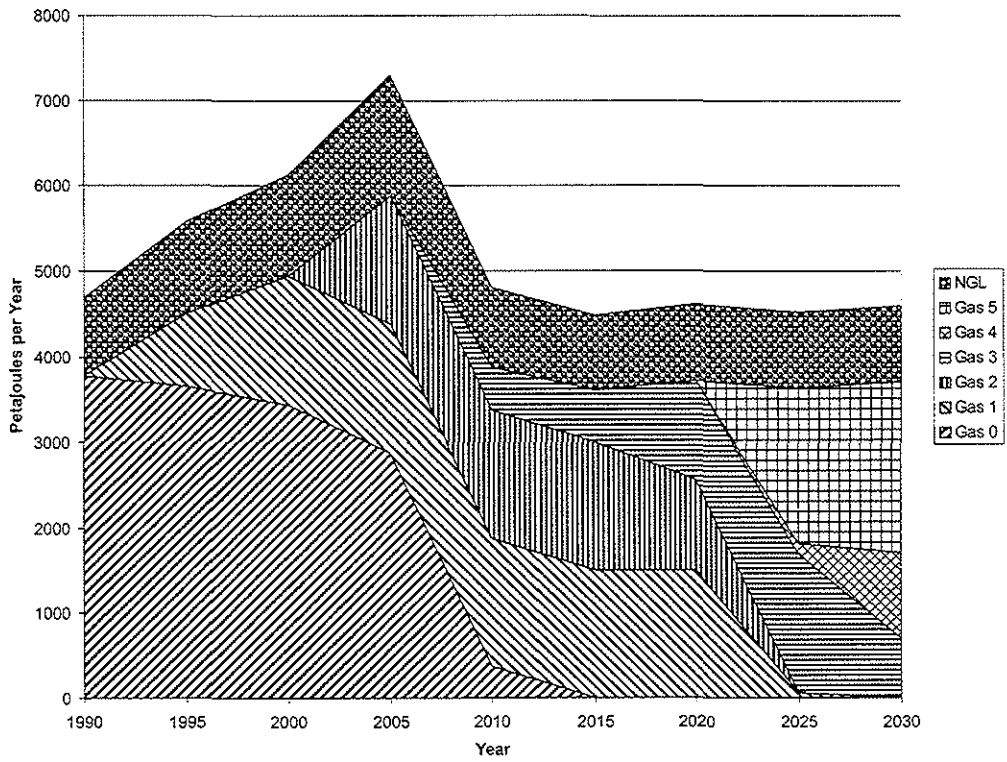

Figure 17 Composition of Natural Gas Extraction in Alberta (Base Case)

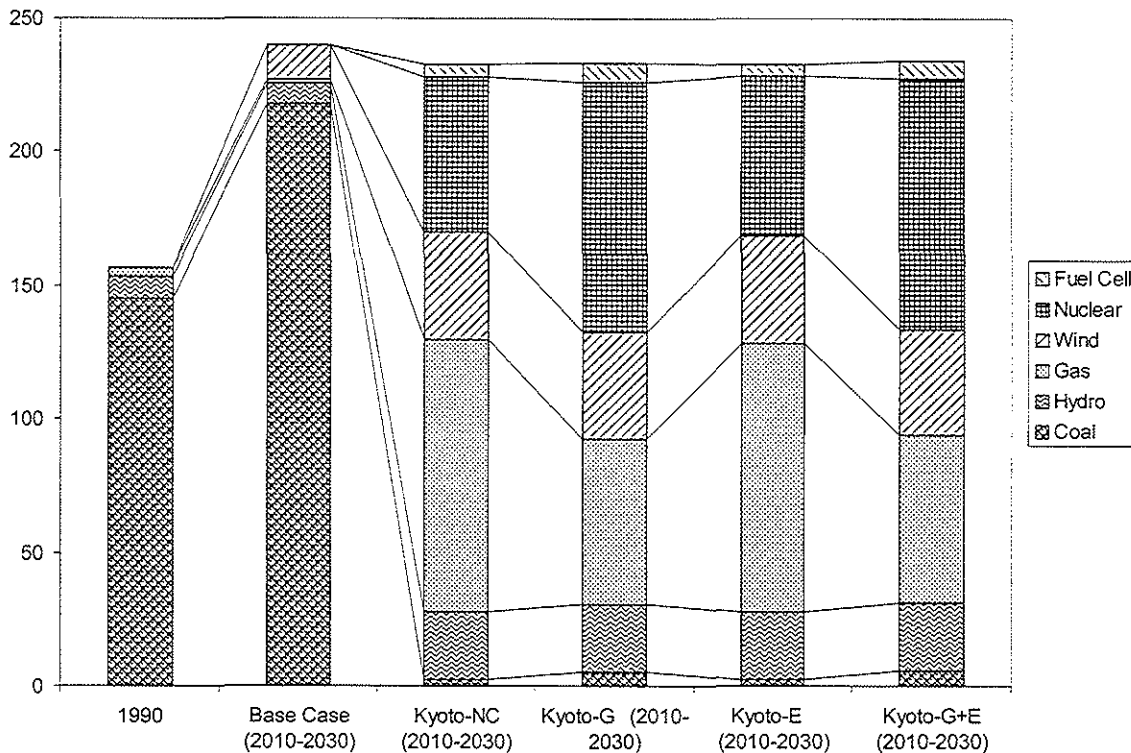

Figure 18 Aggregate Electricity Generation in Alberta

Conclusion

The major finding of this research is that Canada would greatly benefit from internal permit trading and enhanced hydroelectricity development and trading, in order to reach the Kyoto target efficiently. The collective cost savings of these two measures would reduce total direct cost by one fourth. We have also identified the precise techno-economic decisions that would insure that the Kyoto target is reached at minimum direct cost. These involve significant energy switches, but no sudden revolution in the business-as-usual energy technology mixes in each province. Nuclear has been postponed until 2020 in this study, and thus plays only a belated role. However, it could reduce abatement costs significantly if its penetration were allowed earlier. Gas continues to play a major role in Canada, either through conventional technologies, or through gas fuel cells for electricity generation, in the later periods. Oil consumption decreases in the transport sector, where alcohol and electric vehicles penetrate the markets in a progressive

fashion after 2010.

One of the strong features of this research is that it models the North American gas and electricity markets in a credible manner. Many past bottom-up studies have assumed exogenous gas and electricity supply sources, with accordingly diminished realism.

This study has taken the long-term view, even though the Kyoto protocol's deadline is only 12 years ahead. We believe this is essential, and that short-term decisions are indeed partly dependent on the long term objectives pursued. To accommodate this, we have extended the Kyoto target to 2030, via additional mitigation amounts. We fully intend to follow up on this issue, by explicitly introducing uncertainty in the definition of the long term reduction target (i.e. defining several possible targets), and constructing a hedging strategy (rather than perfect foresight strategies), via the Stochastic Programming feature of MARKAL. This will be an important sequel to this article.

The results obtained would be somewhat altered (and the overall cost somewhat reduced) if positive demand elasticities were chosen in most sectors. However, this analysis has on purpose frozen demands at their base case levels, in order to clearly identify the technological solutions for mitigating emissions. Further economic analysis of the strategies elaborated in this research could and should be performed, using economic simulation models. In that way, specific indirect effects on various sectors and on trade would be made more explicit. These effects may be positive or negative.

This article did not set to fully explore the all important issue of permit allocation, which is an equity rather than an efficiency question. However, the remarks made here trace the way to evaluate permit sharing formulas if and when they are proposed by the policy makers.

A natural extension of this research would be to include the other Canadian regions, and this will be done in the future as other MARKAL models are developed. However, the set of provinces selected here represents enough of the diversity (as well as of total economic activity and GHG emissions), to constitute a representative portion of the country.

As discussed in the introduction, the impact of International Joint Mitigation is being investigated in a companion study, whose results would of course alter the conclusions reached here. Therefore, the two studies together will provide a complete set of contingent strategies covering the two main possibilities regarding Joint Mitigation.

Acknowledgments

The authors extend their thanks to MM Sam Wong of Alberta Research Council and Morgan MacRae of the Canadian Energy Research Institute for providing the initial Alberta Database, and to MM Phillip Tseng of the US Department of Energy and Gary Goldstein of Decisonware for providing the US database. Although our work depended on their kind help, we must of course retain full responsibility for any assertions and comments made in this article. Comments by Steve Dobson of Alberta energy have helped improve the Alberta scenarios.

REFERENCES

- Berger, C., Dubois, R., Haurie, A., Lessard, E., Loulou, R., and Waaub, J.-P. 1992 Canadian MARKAL: an advanced Linear Programming System for Energy and Environment Modelling, *INFOR* 20, 114-125.
- Fishbone, L. G. and Abilock, H. 1981. MARKAL-A Linear Programming Model for Energy Systems Analysis: Technical Description of the BNL Version, *International Journal of Energy Research* 5, 353-375.
- IPCC. 1996. *Climate Change 1995: Economic and Social Dimensions of Climate Change*, J.P Bruce, H.Lee and E. Haites (eds), Cambridge University Press, Cambridge, U.K.
- Jepma, C. J and Munasinghe, M. 1998. *Climate Change Policy: Facts, Issues and Analyses*, Cambridge University Press, Cambridge.
- Kanudia A. and Loulou R. 1997. Advanced Bottom-up Modelling for National and Regional Energy Planning in Response to Climate Change, accepted for publication in the *International Journal of Environment and Pollution*. Also available as GERAD discussion paper G-97-14.
- Kanudia A. and Loulou R. 1998. *Robust Energy Technologies via Stochastic MARKAL: The case of Quebec*, *European Journal of Operational Research*, Vol. 106, No. 1, 15-30.
- Kanudia A. and Loulou R. 1998a, *Joint Mitigation under the Kyoto Protocol: A USA-Canada-India Case Study*, GERAD discussion paper G-98-40, 1998. Submitted to *Energy Policy*.
- Loulou, R., and Lavigne, D. 1996. MARKAL Model with Elastic Demands: Application to GHG Emission Control, in *Operations Research and Environmental Engineering*, C. Carraro and A. Haurie eds., Kluwer Academic Publishers, Dordrecht, Boston, London, pp. 201-220.
- Loulou R., Kanudia A., and Lavigne D. 1996. GHG Abatement in Central Canada with Inter-provincial Cooperation, *Energy Studies Review*, Vol. , No. 2, pp. 120-129.

- Loulou, R. and Kanudia A. 1997. Minimax Regret Strategies for Greenhouse Gas Abatement: Methodology and Application, GERAD discussion paper G-97-32.
- Manne, A.S., Rutherford, T. F. 1994. International trade in oil, gas and carbon emission rights: an intertemporal general equilibrium model, *Energy Journal*, Vol. 15(1), 57-76.
- Natural Resources Canada. 1994. Perspectives Énergétiques du Canada 1992-2020.
- UNFCCC. 1992. *United Nations Framework Convention on Climate Change- Articles*, United Nations, New York.
- UNFCCC. 1997. *Kyoto Protocol to the United Nations Framework Convention on Climate Change*, United Nations, New